



# INSTALLATION MANUAL

# AIR CONDITIONER

**Read this installation manual thoroughly before installing the appliance and keep it handy for reference at all times.**

TYPE: WALL MOUNTED

EN English



5400610758 rev.:a



[www.lg.com](http://www.lg.com)

# TABLE OF CONTENTS

This manual may contain images or content different from the model you purchased.

This manual is subject to revision by the manufacturer.

<b>SAFETY INSTRUCTIONS .....</b>	<b>3</b>
IMPORTANT SAFETY INSTRUCTIONS.....	4
<b>PRODUCT OVERVIEW.....</b>	<b>9</b>
Parts.....	9
Local Purchases.....	9
Installation Parts.....	10
Installation Tools.....	10
<b>INSTALLATION PLACE .....</b>	<b>11</b>
Indoor Unit.....	11
Outdoor Unit.....	11
Refrigerant (for R32 Only).....	12
<b>PREPARATION WORK.....</b>	<b>12</b>
Fixing the Installation Plate .....	12
Making a Hole in the Wall.....	12
Preparing the Pipe and Power Cable.....	13
Flare Work.....	13
<b>INSTALLING THE INDOOR UNIT .....</b>	<b>13</b>
Bending the Pipe.....	13
Connecting the Drain Hose .....	14
Installing the Indoor Unit on the Installation Plate .....	14
Connecting the Indoor Unit Pipe .....	14
<b>INSTALLING THE OUTDOOR UNIT .....</b>	<b>15</b>
Fixing the Outdoor Unit .....	15
Connecting the Outdoor Unit Pipe.....	15
Connecting the Drain Plug .....	15

<b>CONNECTING THE POWER CABLE .....</b>	<b>16</b>
Power Supply Cable.....	16
Inter-Connecting Cable .....	16
Circuit Breaker.....	16
Connecting the Wires .....	16
Indoor Unit.....	16
Outdoor Unit.....	17
<b>FINALIZING INSTALLATION.....</b>	<b>17</b>
Wrap of Pipe Connection with Insulation.....	17
Wrapping Up the Pipe, Drain Hose, and Power Cable.....	17
Finalizing the Indoor Unit Installation .....	18
Checking the Drainage.....	18
<b>CHECK AFTER INSTALLATION .....</b>	<b>19</b>
Vacuum .....	19
Check-Up for Gas Leakage.....	19
Test-Running .....	20
Checking the Performance.....	20
<b>SETTING THE MODE .....</b>	<b>20</b>
Setting the Cooling / Heating Only Mode .....	20
Canceling the Cooling / Heating Only Mode .....	20
<b>CHARGING THE REFRIGERANT .....</b>	<b>21</b>
<b>PUMP DOWN.....</b>	<b>22</b>

# SAFETY INSTRUCTIONS

The following safety guidelines are intended to prevent unforeseen risks or damage from unsafe or incorrect operation of the appliance.

The guidelines are separated into 'WARNING' and 'CAUTION' as described below.

 This symbol is displayed to indicate matters and operations that can cause risk. Read the part with this symbol carefully and follow the instructions in order to avoid risk.

 **WARNING**

This indicates that the failure to follow the instructions can cause serious injury or death.

 **CAUTION**

This indicates that the failure to follow the instructions can cause the minor injury or damage to the product.

The following symbols are displayed on indoor and outdoor units.



This symbol indicates that this appliance uses a flammable refrigerant. If the refrigerant is leaked and exposure to an external ignition source, there is a risk of fire.



This symbol indicates that the Operation Manual should be read carefully.



This symbol indicates that a service personnel should be handling this equipment with reference to the Installation Manual.



This symbol indicates that information is available such as the Operating Manual or Installation Manual.

## IMPORTANT SAFETY INSTRUCTIONS

### WARNING

**To reduce the risk of explosion, fire, death, electric shock, injury or scalding to persons when using this product, follow basic precautions, including the following:**

- The information contained in the manual is intended for use by a qualified service technician who is familiar with the safety procedures and equipped with the proper tools and test instruments.
- The appliance shall be installed in accordance with national wiring regulations.
- Compliance with national gas regulations shall be observed.
- Means for disconnection must be incorporated in the fixed wiring in accordance with the wiring rules.
- If the supply cord is damaged, it must be replaced by the manufacturer or its service agents or similarly qualified person in order to avoid a hazard.
- Appliance shall be disconnected from its power source during service and when replacing parts.
- Failure to read and follow all instructions in this manual can result in equipment malfunction, property damage, personal injury and/or death.
- Check that the appliance's voltage level is 90 % or higher than the rated voltage. To check it, refer to the label attached to the side of the appliance.
- Do not install the appliance on an unstable surface or in a place where there is danger of it falling.
- This appliance must be grounded. In the event of malfunction or breakdown, grounding will reduce the risk of electric shock by providing a path of least resistance for electric current.
- Improper connection of the equipment-grounding conductor can result in risk of electric shock. Check with a qualified electrician or service personnel if you are in doubt as to whether the appliance is properly grounded.

- If the power supply cable is damaged or the cable connection is loose, do not use the power supply cable and contact an authorized service center.
- Do not connect the ground wire to a gas pipe, a lightning rod, or a telephone ground wire.
- Do not share the power supply for this unit with other appliances or devices, it must be a dedicated power source for this appliance.
- Do not modify or extend the power cable.
- Ensure the power cable is secure so that it does not come out while the appliance is operating.
- Do not touch the power plug or the appliance controls with wet hands.
- Cut the power during a severe thunderstorm or lightening or when not in use for a long period of time.
- Do not grab the power cable when removing the plug, but rather hold the power plug tightly.
- Do not bend the power cable excessively or place a heavy object on it.
- Do not turn on the circuit breaker or power when covers are removed or opened.
- Make sure that the pipe and the power cable connecting the indoor and outdoor units are not pulled too tight when installing the appliance.
- Install dedicated electric outlet and circuit breaker for the appliance.
- Make sure to close the cover of the control box after connecting the wiring to the appliance.
- Loose connections may cause electrical sparks, injury, and death.
- Do not install the appliance in a place where flammable liquids or gases such as gasoline, propane, paint thinner, etc., are stored.
- Only use the refrigerant designated on the label, do not put any foreign substances into the appliance.

- Any person who is involved with working on or breaking into a refrigerant circuit should hold a current valid certificate from an industry-accredited assessment authority regard of flammable refrigerants, which authorizes their competence to handle refrigerants safely in accordance with an industry recognized assessment specification.
- Servicing shall only be performed as recommended by the equipment manufacturer. Maintenance and repair requiring the assistance of other skilled personnel shall be carried out under the supervision of the person competent in the use of flammable refrigerants.
- Keep any required ventilation openings clear of obstruction.
- Refrigerant tubing shall be protected or enclosed to avoid damage.
- Flexible refrigerant connectors (such as connecting lines between the indoor and outdoor unit) that may be displaced during normal operations shall be protected against mechanical damage.
- Mechanical connections shall be accessible for maintenance purposes.
- A brazed, welded, or mechanical connection shall be made before opening the valves to permit refrigerant to flow between the refrigerating system parts.
- Use non-flammable gas (nitrogen) to check for leak and to purge air.
- Use only refrigerant grade pipe specific for R32 refrigerant. Do Not Use R22 products, which have lower pressure ratings and can result in excessive pressure, explosion and injury.
- Inert gas (oxygen free nitrogen) should be used when you checking for leaks, cleaning or repairs of pipes etc. If you are using combustible gases including oxygen, appliance may have the risk of fires and explosions.
- Do not use copper pipes which are deformed. Otherwise, the expansion valve or capillary tube may become blocked with contaminants.
- Ducts connected to an appliance shall not contain an ignition source.

- The installation of pipe-work shall be kept to a minimum.
- When installing or relocating the appliance, consult with a qualified technician to set up the appliance. The appliance should not be installed by someone without proper qualifications.
- Operating the appliance while it is disconnected to the pipe could result in explosion and damage. Use the appliance after connecting it to the pipe once the appliance has been relocated and the refrigerant circuit repaired.
- Do not place a heater or other heating appliances near the power cable.

 **CAUTION**

**To reduce the risk of minor injury to persons, malfunction, or damage to the product or property when using this product, follow basic precautions, including the following:**

- Install at places where it can endure the weight and vibration/noise of the outdoor unit.
- Install the appliance in a place where the noise from the outdoor unit or the exhaust air will not inconvenience the neighbors. Failure to do so may result in conflict with the neighbors.
- Ensure the appliance is installed level. Otherwise, it may cause vibration or water leakage.
- Install the drain hose properly for the smooth drainage of water condensation.
- Do not touch the leaking refrigerant during installation or repair.
- Do not discharge the refrigerant into the atmosphere.
- If refrigerant leaks, ventilate the room.
- Always check for gas (refrigerant) leakage after installation or repair of appliance.
- Be cautious not to get injured by the sharp edges while installing the appliance or taking it out of its packaging.

- Ensure that you carry by the chassis when you lift the unit.
- This appliance should only be transported by two or more people holding the appliance securely.
- Safely dispose of packing materials such as screws, nails or batteries using proper packaging after installation or repair.
- To avoid nitrogen entering the refrigerant system in a liquid state, the top of the cylinder must be higher than its bottom when you pressurize the system.
- The tubing shall be protected to the extent that it will not be handled or used for carrying during moving of the appliance.
- Ventilation system have to be installed in the space when appliance with R32 is using for cooling of electric equipment.
- Do not use the appliance for special purposes, such as preserving foods, works of art, and etc. It is an appliance for consumer purposes, not a precision refrigerant system. There is risk of damage or loss of property.



## PRODUCT OVERVIEW

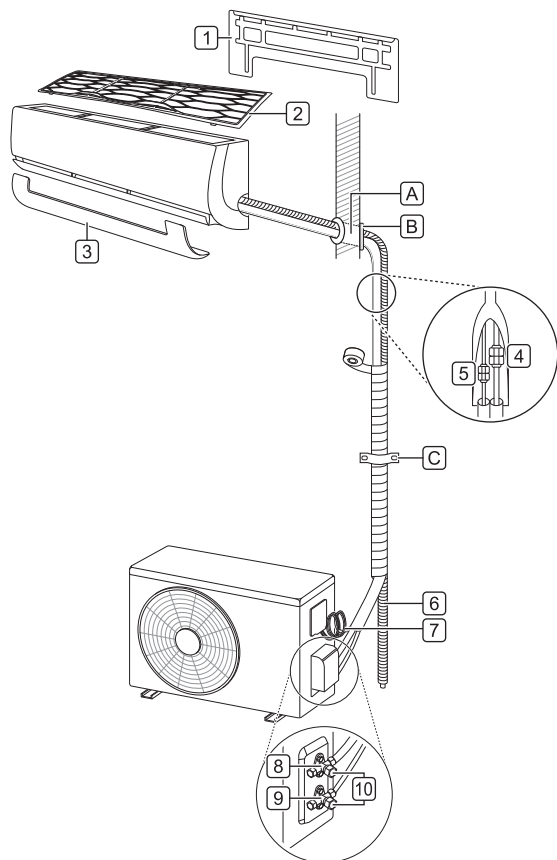

## Parts

- 1 Installation Plate
- 2 Air Filter
- 3 Decor
- 4 Gas Pipe (Larger Pipe)
- 5 Liquid Pipe (Smaller Pipe)
- 6 Drain Hose
- 7 Power Supply Cable
- 8 Gas Service Valve
- 9 Liquid Service Valve

- This feature could be different depending on models.

- 10 (Gas/Liquid) Service Valve Cap

## NOTE

- If needed, additional pipes, drain hoses, and power cables must be purchased separately.
- When mechanical connectors are reused indoors, sealing parts shall be renewed.

## Local Purchases

It is highly recommended that you install the following parts:

- A Sleeve
- B Sealant
- C Clamp

## Installation Parts

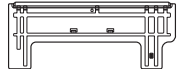

Installation Plate (Type A)

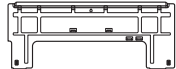

Installation Plate (Type B)



Remote Control Holder



Type 'A' Screws  
(for Installation Plate)



Type 'B' Screws  
(for Remote Control Holder)



Type 'C' Screws  
(for Chassis)



Connectors (Optional)

### Connector

Capacity (kW)	Qty	Pipe Size			
		mm	inch	mm	inch
5.0	1	Ø 9.52	Ø 3/8	Ø 12.70	Ø 1/2

### NOTE

- When indoor unit (5.0 kW) is connected to the Multi outdoor unit, use the connector.

## Installation Tools



Phillips Screwdriver



Standard Screwdriver



Electrical Drill

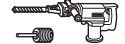

Hole Core Drill



Adjustable Wrench



Torque Wrench



Spirit Level



Tape Measure



Tube Cutter

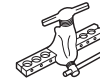

Tube Expander



Reamer



Cutting Knife



Hexagon Wrench



Thermometer



Gas Leak Detector  
(R32)



Current Meter



Manifold Gauge  
(R32)

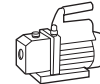

Vacuum Pump  
(R32)



Reclaim Unit  
(R32)



Ventilation Equipment  
(R32)

### NOTE

- Leakage detector which is confirmed rated for use with R32, should be used when you are checking for leaks.
- Under no circumstances shall potential sources of ignition be used in the searching for or detection of refrigerant leaks. A halide torch (or any other detector using a naked flame) shall not be used.
- Ventilation Equipment: For AC system using R32 (A2L gases) a ventilation equipment with "Ex" mark only should be used when a system design exceeds the Lower Flammable Limit if the gas was to escape from a system.

# INSTALLATION PLACE

## Indoor Unit

- Install the indoor unit on a strong and hard wall.
- Install the indoor unit in a spot with good drainage and good accessibility to the pipe connected to the outdoor unit.
- Maintain a clearance of at least 100 mm from the right and left sides of the indoor unit.
- Maintain a clearance of at least 200 mm from the top of the indoor unit and the ceiling.

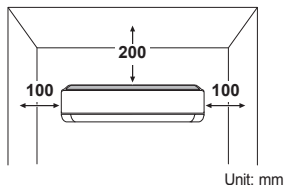

### NOTE

- Do not install the indoor unit near heaters or heating apparatuses.
- Do not install the indoor unit near an obstacle that hinders airflow.
- Do not install the indoor unit near an exit.
- Do not install the indoor unit where it can be exposed to direct sunlight.

## Outdoor Unit

- Install the outdoor unit in a location where the floor is firm and even.
- Install the outdoor unit where hot wind or noise will not disturb neighbor.
- Install the outdoor unit somewhere the technician can easily access it for repairs or maintenance.
- Maintain a clearance of 300 mm from the left and the back (air inlet) sides and 600 mm from the right sides of the outdoor unit.
- If there is an obstacle in front of the air vent, keep the outdoor unit at a distance of at least 700 mm from the obstacle.

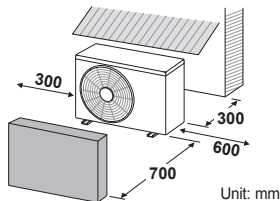

### NOTE

- Do not install the outdoor unit where a location is unstable or may vibrate.
- Do not install the outdoor unit in a location exposed to saline conditions, such as coastal areas, or sulfuric steam, such as near a hot spring.
- Do not install the outdoor unit in a location exposed to high winds.
- Do not install the outdoor unit somewhere exposed to direct sunlight. (Otherwise, make sure to put up a protective awning.)
- Do not keep any animals or plants near the air vent.

## Precautions for Installation in Coastal Areas

- Do not install the appliance in an area where it is directly exposed to sea air (salt spray).
  - Saline conditions are a cause of corrosion. (Particularly, corrosion of the condenser and evaporator can damage the appliance or impair its performance.)

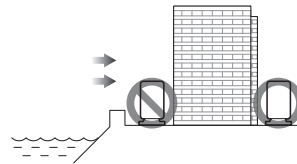

- Set up windbreak in front of the outdoor unit if installing it in coastal areas.
  - Avoid direct exposure to salt winds.
  - Install a firm and stiff concrete-wind shield that can withstand salt winds.

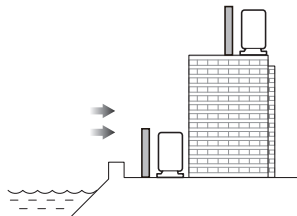

### NOTE

- If you have to set up the outdoor unit in a coastal area, unless the installation conditions are able to satisfy the above precautions, call an LG Electronics Customer Service Center to find out about alternatives.

## Precautions for Installation in Special Regions (Snowfall, Strong Winds, Area with Severely Cold or Humid Weather)

- Install the outdoor unit where the airflow fans are protected from being buried under snow. Accumulated snow could cause the device to malfunction by clogging the airflow.
- Install the outdoor unit on a platform at least 500 mm above the ground where a location has heavier snowfall than the annual average. (The size of the platform should correspond with the size of the outdoor unit. If the platform is wider or longer than the outdoor unit, snow may accumulate.)
- Put a snow-protective cover on the outdoor unit.
- Place the inlet and outlet for the outdoor unit in opposite directions to direct airflow and to prevent snow and rain from flowing into the equipment.
- Install the outdoor unit in a spot that is well lit and well ventilated in highly humid areas (near sea or fresh water bodies).

## Refrigerant (for R32 Only)

### ⚠ WARNING

- The appliance shall be stored in a well-ventilated area where the room size corresponds to the room area as specified for operation.
- The appliance shall be stored in a room without continuously operating open flames (for example an operating gas appliance) and ignition sources (for example an operating electric heater).
- The appliance shall be stored so as to prevent mechanical damage from occurring.
- Do not use means to accelerate the defrosting process or to clean, other than those recommended by the manufacturer.
- Do not pierce or burn.
- Be aware that refrigerants may not contain an odour.
- Pipe-work shall be protected from physical damage and shall not be installed in an unventilated space, if that space is smaller than the minimum floor area.

### Minimum Floor Area

m (kg)	Minimum Floor Area (m <sup>2</sup> )		
	Floor Standing	Wall Mounted	Ceiling Mounted
< 1.224	-	-	-
1.224	12.90	1.43	0.956
1.2	12.36	1.37	0.92
1.4	16.82	1.87	1.25
1.6	21.97	2.44	1.63
1.8	27.80	3.09	2.07
2.0	34.32	3.81	2.55
2.2	41.53	4.61	3.09
2.4	49.42	5.49	3.68

- m: Total refrigerant amount in the system
- Total refrigerant amount: Factory refrigerant charge + Additional refrigerant amount

### NOTE

- The actual refrigerant charge is in accordance with the room size within which the refrigerant containing parts are installed.
- The ventilation machinery and outlets are operating adequately and are not obstructed.
- If an indirect refrigerating circuit is being used, the secondary circuit shall be checked for the presence of refrigerant.
- Marking to the equipment continues to be visible and legible. Markings and signs that are illegible shall be corrected.
- Refrigeration pipe or components are installed in a position where they are unlikely to be exposed to any substance which may corrode refrigerant containing components, unless the components are constructed of materials which are inherently resistant to being corroded or are suitably protected against being so corroded.

## PREPARATION WORK

### Fixing the Installation Plate

To securely fasten the indoor unit, fix the installation plate onto a wall.

- Separate the installation plate equipped on the back of the indoor unit.
- Confirm the location where you will place the installation plate.
  - Choose a strong and hard wall that can withstand the weight of the indoor unit.
- Securely fix the installation plate onto the wall with type 'A' screws.
  - Tighten a screw into the center hole (○) of the installation plate.
  - Ensure the installation plate is horizontal using a spirit level.
  - Tighten the remaining screws into the holes indicated by the arrow on the installation plate.

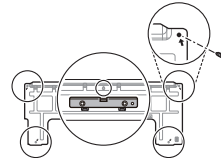

### NOTE

- If installing the installation plate onto a weak or insufficiently hard wall, utilize an anchor bolt.
- If the installation plate is set unevenly, water may not drain smoothly and result in leakage into the room.

### Making a Hole in the Wall

Put a hole into the wall to connect the power cable, drain hose, and pipes attaching the indoor device to the outdoor one.

- Confirm the location of the hole you are going to add.
  - Measure the distance from the installation plate.
    - Refer to the measure indicated on the installation plate.

#### Framework of Indoor Unit

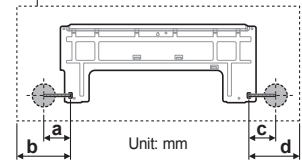

	Type A	Type B
a	98	83
b	152	134
c	134	83
d	194	150

- Make a hole in the wall by  $\varnothing 65$  mm hole core drill.
  - To facilitate drainage flow, drill the hole at an oblique angle from the inside going outside. (The inclination of the hole could be different depending on the specific conditions.)

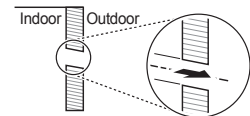

## Preparing the Pipe and Power Cable

Once the gap between the indoor unit and the outdoor unit one has been measured, cut the pipe and power cable to the proper length.

- Cut the pipe slightly longer than the measurement.
- Cut the power cable 1.5 m longer than the pipe.

### NOTE

- If you purchase the pipe separately, do not use thinner pipe than the specified value.
- Use the deoxidised copper as piping materials to install.

## Flare Work

Flaring must be performed accurately to prevent any gas leakage.

- 1 Cut the pipe with a copper tube cutter.



- 2 Remove the burrs using a reamer.

- Hold the edge of the cut pipe so it is pointing downward and remove the burrs. This helps prevent metal powder from getting into the pipe.



- 3 Put the flare nut onto the pipe (burr is removed).



- 4 After inserting the pipe into the tube expander, begin flaring.

- As seen in diagram "a", put the pipe slightly above the upper side of the Bar.

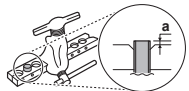

- Refer to the measurements for "a".

Pipe Size		a (Wing Nut)	Thickness
mm	inch	mm	mm
Ø 6.35	Ø 1/4	1.1~1.3	0.7
Ø 9.52	Ø 3/8	1.5~1.7	0.8
Ø 12.70	Ø 1/2	1.6~1.8	0.8
Ø 15.88	Ø 5/8	1.6~1.8	1.0

### NOTE

- a (Clutch): 0.0~0.5 mm
- Temper grade of pipe: Annealed

- 5 Check out the condition of the flare.

- Check that the flared section of the pipe (1) was flared evenly in its curved surface and thickness.
- Make sure all flared surfaces (2) have been flared smoothly.

### Example of Correct Flaring

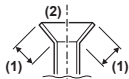

### Example of Incorrect Flaring



### NOTE

- If the expanded pipe has tilting, surface damage, cracks, or a thickness imbalance, perform the flaring operation again.
- When flared joints are reused indoors, the flare part shall be re-fabricated.

## INSTALLING THE INDOOR UNIT

### Bending the Pipe

- 1 Pull out the decor at the bottom of the indoor unit.

- Hold the centre of the decor (1) and pull it towards you. Then, pull both sides of the decor out (2).

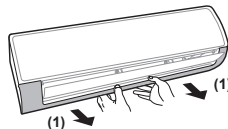

### Position of Hooks



### NOTE

- The quantity and position of the hooks could be different depending on models.

- 2 Open the tubing holder at the back of the indoor unit.

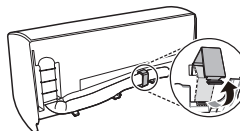

- 3 After straightening the pipe gradually downward, bend it to the direction to be installed.

### Correct Example of Bending the Pipe

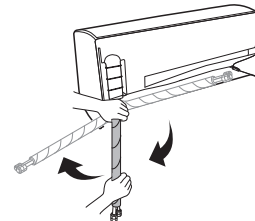

### Incorrect Example of Bending the Pipe

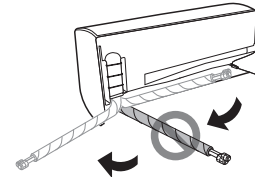

### NOTE

- The pipe can be damaged if you bend it directly from right to left.

## Connecting the Drain Hose

- 1 Remove the drain cap where you are going to connect the drain hose.
  - If you do not use the other drain hose hole, block it with a drain cap.

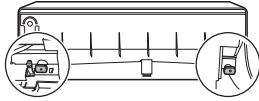

- 2 Insert the drain hose.

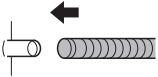

## Extending the Drain Hose

- 1 Insert the extending hose into the drain hose joint.

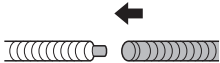

- 2 Wrap the joint area with vinyl tape at least 10 times.

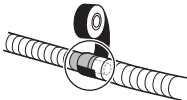

### NOTE

- The indoor extended drain hose should be wrapped in insulation to decrease the amount of leakage. You can purchase insulation material separately.

## Installing the Indoor Unit on the Installation Plate

Put the indoor unit onto the installation plate fixed on the wall.

- Check if the hook on top of the rear part of the indoor unit is securely fastened onto the installation plate.

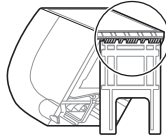

## Connecting the Indoor Unit Pipe

- 1 By reclining the tubing holder, make a space between the bottom of the indoor unit and the wall.

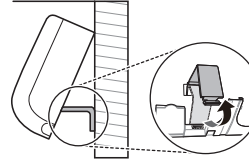

- 2 Remove each of the flare nuts attached to the pipes of the indoor unit.

- First, secure the pipe with an adjustable wrench and then, loosen the flare nut using a torque wrench.

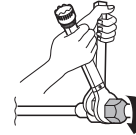

- 3 Tighten the flare nut after inserting the pipe engaged with the flare nut through the centre of the indoor unit's pipe.
  - After fixing the pipe with the help an adjustable wrench, securely tighten the flare nut using a torque wrench.

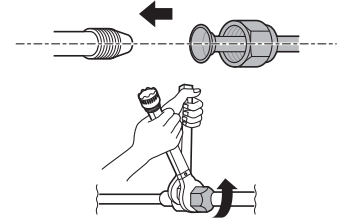

Pipe Size		Torque	
mm	inch	kgf·cm	N·m
Ø 6.35	Ø 1/4	180~250	17.6~24.5
Ø 9.52	Ø 3/8	340~420	33.3~41.2
Ø 12.70	Ø 1/2	550~660	53.9~64.7
Ø 15.88	Ø 5/8	630~820	61.7~80.4

### NOTE

- To prevent gas leakage, apply refrigeration oil on both inner and outer surfaces of the flare.

# INSTALLING THE OUTDOOR UNIT

## Fixing the Outdoor Unit

Fix the outdoor unit firmly to prevent it from falling and dropping.

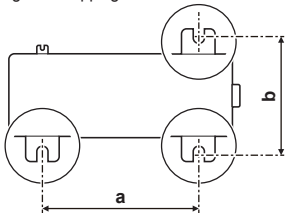

- Refer to the measurements for "a" and "b", depending on the type of chassis. (Chassis type is marked inside the top of the outdoor unit packing box.)

Name of Chassis	a (mm)	b (mm)
UA3	463	256
UL	519	267
UL2	558	329
UE	546	340
UE1	546	340
U24A	586	366
U4	620	360

### NOTE

- If you install the outdoor unit on a wall, roof, or rooftop, make sure it's mounted on a suitable frame.
- If the outdoor unit vibrates excessively, secure it using anti-vibration rubber between the unit's feet and the mounting frame.

## Connecting the Outdoor Unit Pipe

- Open the tubing cover.

### Type 1

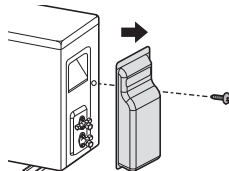

### Type 2

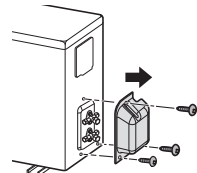

- Remove each of the flare nuts attached to the valves of the outdoor unit.

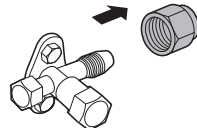

- Tighten the flare nut after inserting the pipe engaged with the flare nut through the centre of the outdoor unit's valve.

- After fixing the valve with the help of an adjustable wrench, securely tighten the flare nut using a torque wrench.

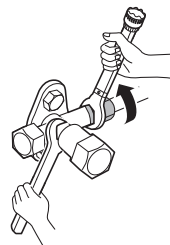
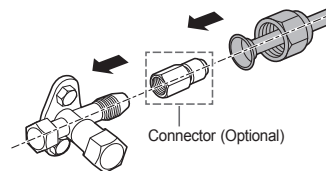

Pipe Size		Torque	
mm	inch	kgf·cm	N·m
Ø 6.35	Ø 1/4	180~250	17.6~24.5
Ø 9.52	Ø 3/8	340~420	33.3~41.2
Ø 12.70	Ø 1/2	550~660	53.9~64.7
Ø 15.88	Ø 5/8	630~820	61.7~80.4

### NOTE

- To prevent gas leakage, apply refrigeration oil on both inner and outer surfaces of the flare.
- When indoor unit (5.0 kW) is connected to the Multi outdoor unit, use the connector.

## Connecting the Drain Plug

If you need to install a drain hose onto an outdoor unit, connect the drain hose after inserting the drain plug with drain washer through the drain hole on the bottom of the outdoor unit.

### Accessories

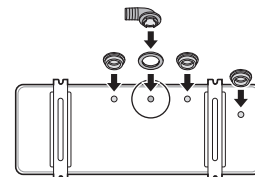

### NOTE

- If the hole is not in use, block it with the drain cap.
- The quantity and position of the drain cap could be different depending on models.
- In cold areas, do not use the drain hose on the outdoor unit because the water drained out from the drain hose can freeze, which may cause malfunctioning by damaging the heat exchanger.

# CONNECTING THE POWER CABLE

- All power wiring/communication cables must comply with applicable local and national codes.
- The cable specification for outdoor use shall not be less than polychloroprene sheathed flexible cord. (code designation 60245 IEC 57, H05RN-F)
- The earth wire should be longer than the common wires.

## Power Supply Cable

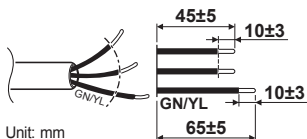

Unit: mm

Nominal Cross Sectional Area (Minimum)	Capacity (kW)	
	2.5 / 3.5	5.0
1.0 mm <sup>2</sup>	1.5 mm <sup>2</sup>	

## Inter-Connecting Cable

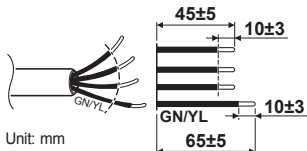

Unit: mm

Nominal Cross Sectional Area (Minimum)	Capacity (kW)
	1.5 / 2.1 / 2.5 / 3.5 / 4.2 / 5.0
1.0 mm <sup>2</sup>	

## Circuit Breaker

Between the power and the appliance, install a certified circuit breaker. The interrupting device should be equipped to properly block all power sources.

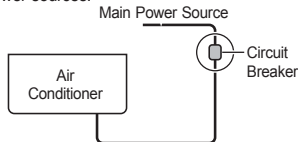

Circuit Breaker (A)	Capacity (kW)	
	2.5 / 3.5	5.0
15	20	

### NOTE

- Check whether the current capacity of the selected cable and wiring exceeds the rated capacity of the recommended circuit breaker.

## Connecting the Wires

- The distance between wires should be more than 5 mm.

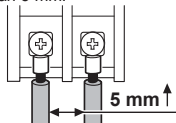

- Connect the wire after inserting the circular terminal.



## CAUTION

- Without exception, install an independent power circuit specifically designed for the appliance. Refer to the circuit diagram attached inside the control cover for where to connect the cable.
- Screw connections in the appliance's control box can vibrate loose during transporting and operating the appliance. Check that all the connections in the appliance are securely fixed at all times. (If they have loosened, both the wire and the termination can be broken.)

### NOTE

- Circuit diagrams may be altered by the manufacturer without any notification.

## Indoor Unit

- After loosening the screw that is holding the cover in place, pull the cover up.

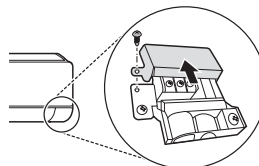

- Open the clamp cord.

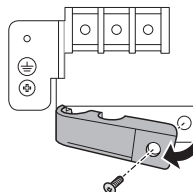

- After pairing both wires and the ground wire with the terminal block, fasten them securely by tightening the screws.

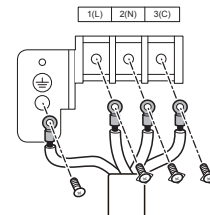

- Close the clamp cord again and secure it with a screw.

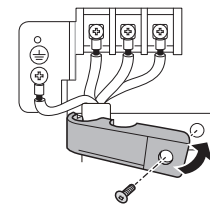

- Close the cover again and secure it with the screw.

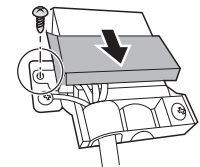

## CAUTION

- Loose screws may cause electrical sparks, injury, and death.



## Outdoor Unit

- 1 Open the tubing cover (Type 1) or the control cover (Type 2).

Type 1

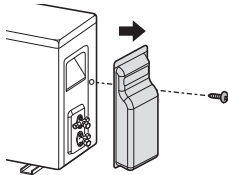

Type 2

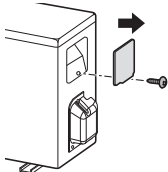

- 2 After pairing both the wires and the ground wire with the terminal block, fasten them securely by tightening the screws.
  - The color of the wire for the outdoor unit and the terminal number should be the same as that of the indoor unit.

Type 1

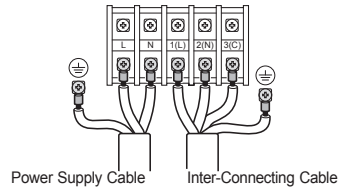

Type 2

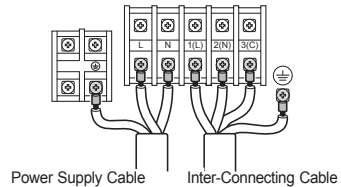

Type 3

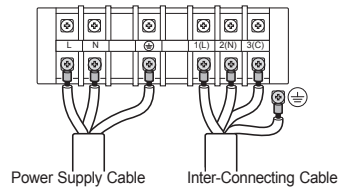

- 3 After closing the tubing cover or control cover, secure them with screw.

## FINALIZING INSTALLATION

### Wrap of Pipe Connection with Insulation

Bind the pipe connecting area with insulator and securely tie with vinyl tape.

- Wrap up the pipes with insulator to prevent gaps between them.
- Make the cutting line of the insulator wrapping the pipe face the upper direction.

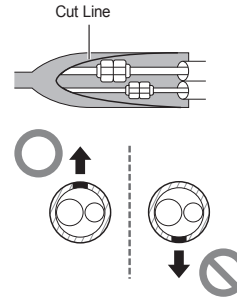

### NOTE

- For left rear piping, bundle the piping and drain hose together by wrapping them cloth tape over the range within which they fit into the rear piping housing section.
  - Wrap the piping of the indoor unit that are visible from the outside with vinyl tape.



### Wrapping Up the Pipe, Drain Hose, and Power Cable

If the Outdoor Unit is Placed Below the Indoor Unit

- 1 Partially tie up the overlapping lines of pipe, drain hose, and power cable using thin vinyl tape.



- 2 Use wide vinyl tape to fully tie up all the lines (pipe, drain hose, and power cable).
  - Start winding from the bottom up.

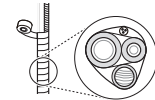

- 3 Trap the power cable.

- This can prevent the electrical components from coming into contact with water.

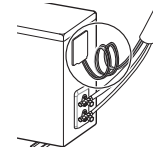

- 4 Close the tubing cover.

### If the Outdoor Unit is Above the Indoor Unit

- 1 Partially tie up the overlapping lines of pipe, and power cable using thin vinyl tape.
- 2 Use wide vinyl tape to fully tie up all the lines (pipe, and power cable).
  - Start winding from the bottom up.

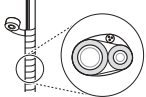

- 3 Trap both the pipe and the power cable.
  - This can prevent the room and the electrical components from coming into contact with water.

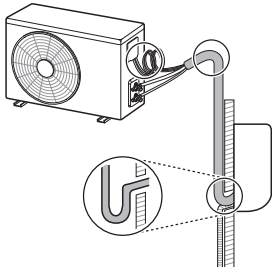

- 4 Close the tubing cover.

### NOTE

- Apply sealant around the pipe going through the hole in the wall. This sealant can prevent the indoor air from being contaminated by outdoor air and foreign substances.

## Finalizing the Indoor Unit Installation

- 1 Close the tubing holder.

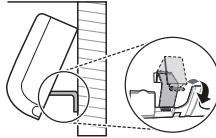

- 2 Push both sides (right and left) of the indoor unit toward the installation plate.



- 3 Fix the indoor unit on the installation plate using 'C' type screws.

- Unless the indoor unit is fixed onto the installation plate securely, it may fall. Tighten the screws firmly to avoid a gap between the indoor unit and the installation plate.

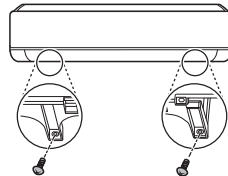

- 4 Reassemble the separated decor to the indoor unit.

## Checking the Drainage

- 1 Remove the filter.
  - Pull the filter up and out towards you.

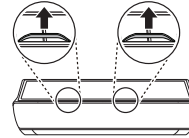

### NOTE

- Do not touch the metal part of the appliance when removing the filter.

- 2 Pour a cup of water into the back of the evaporator.

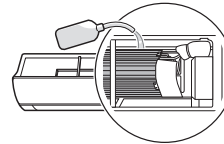

- 3 Check the drainage condition.

- Check whether there is any leakage from either the drain hose joint or the extended hose joint.
- Check the water is flowing out through the drain hose.

### NOTE

- If there is no leakage, but no water is flowing, pour a proper amount of water again.

- 4 Insert the filter again.

### Example of Correct Drain Hose Installation

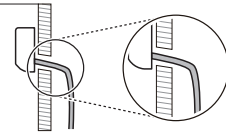

### Example of Incorrect Drain Hose Installation

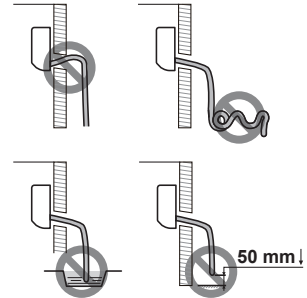

### NOTE

- If the drain hose is not installed properly, water can leak indoors.
  - If the drain hose is installed at a higher position than the indoor unit
  - If the drain hose is entangled or kinked
  - If the end of the drain hose is dipped in water
  - If the gap between the end of the drain hose and the bottom is lower than 50 mm

# CHECK AFTER INSTALLATION

## Vacuum

Residual air or vapor in the refrigerant system can lower appliance performance. To increase cooling and heating performance, remove air or vapor remaining in the refrigerant system using the vacuum pump.

- Work the vacuuming through the gas service valve (larger pipe).
- 1 Remove the caps from the gas service valve (1), the liquid service valve (2), and the core valves (3) in the outdoor unit.

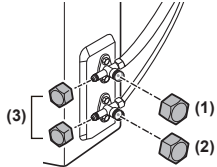

- 2 Connect the low-pressure hose of the manifold gauge to the core valve of the gas service valve.

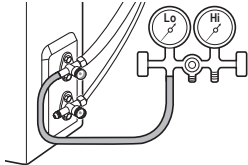

- 3 Connect the charging hose of the manifold gauge to the vacuum pump.

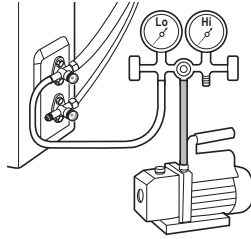

- 4 Open the low-pressure valve of the manifold gauge, and operate the vacuum pump.

- Operate the vacuuming until the pressure gauge is at -30 in. Hg (-76 cm Hg).

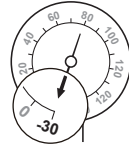

- The time for vacuuming could be different depending on pipe lengths.

If the pipe is shorter than 10 m (33 ft)	If the pipe is longer than 10 m (33 ft)
Longer than 10 minutes	Longer than 15 minutes

### NOTE

- Make sure to check for gas leakage unless the vacuuming works for a long time.

- 5 After completing the vacuum operation, close the low-pressure valve of the manifold gauge.

- 6 Open fully both the gas service valve and liquid service valve of the outdoor unit.

- Rotate the valves to counter-clockwise using a hexagon wrench.

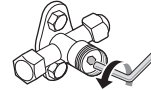

## Check-Up for Gas Leakage

Gas leakage can damage the appliance's performance. Check for gas leakage by applying soapy water on the outdoor unit pipe connected to the indoor unit pipe's joint.

- If there is gas leakage, bubbling will occur.
- In case of bubbling, check the cause of the gas leakage.

### NOTE

- Electronic leak detectors shall be used to detect flammable refrigerants, but the sensitivity may not be adequate, or may need re-calibration. (Detection equipment shall be calibrated in a refrigerant-free area.)
- Leak detection equipment shall be set at a percentage of the LFL (Lower flammable limit) of the refrigerant and shall be calibrated to the refrigerant employed and the appropriate percentage of gas (25 % maximum) is confirmed.
- Leak detection fluids are suitable for use with most refrigerants but the use of detergents containing chlorine shall be avoided as the chlorine may react with the refrigerant and corrode the copper pipe-work.
- If a leak is suspected, all naked flames shall be removed/extinguished.
- If a leakage of refrigerant is found which requires brazing, all of the refrigerant shall be recovered from the system, or isolated (by means of shut off valves) in a part of the system remote from the leak.
- Oxygen free nitrogen (OFN) shall be purged through the system both before and during the brazing process.

## Test-Running

Press the **ON/OFF** button for 3 to 5 seconds for test operation.

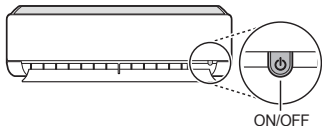

### NOTE

- Make sure that the pipe and the power cable are connected properly.
- For the operating the appliance, check whether both the gas service valve and the liquid service valve of the outdoor unit are fully opened.
- The feature and position of the button could be different depending on models.

## Checking the Performance

After operating the appliance for 15-20 minutes, check the list below;

- 1 Check the pressure of the gas service valve.

Outdoor Temperature	Pressure of Service Valve (Gas)
20 °C (68 °F)~ 35 °C (95 °F)	8.4~9.5 kgf/cm <sup>2</sup> G (120~135 psi)
35 °C (95 °F)~ 40 °C (104 °F)	9.5~10.5 kgf/cm <sup>2</sup> G (135~150 psi)
40 °C (104 °F)~ 45 °C (113 °F)	10.5~11.6 kgf/cm <sup>2</sup> G (150~165 psi)
45 °C (113 °F)~ 48 °C (118 °F)	11.6~12.3 kgf/cm <sup>2</sup> G (165~175 psi)

### NOTE

- If the actual pressure is higher than shown, the refrigerant system is most likely overcharged, and charge should be removed. If the actual pressure are lower than shown, the refrigerant system is most likely undercharged, and charge should be added.
- 2 Measure the temperature of the inlet and the outlet of the indoor unit.
    - A difference of eight degrees Celsius between the inlet and the outlet indicates that the cooling performance is in normal.
  - 3 Separate the low-pressure hose of the manifold gauge from the outdoor unit.
  - 4 Close the core valve cap of the gas service valve.
    - Tighten the core valve cap securely with an adjustable wrench.

## SETTING THE MODE

### Setting the Cooling / Heating Only Mode

- 1 Supply the power to the appliance.
- 2 Reset the appliance.

#### [Method 1]

- Press the **(A)** button and **Reset** button at once.

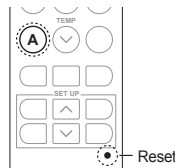

#### [Method 2]

- Insert a battery with pressing **(A)** button.



- 3 Setting the code number then, press **(Ⓞ)** button.

Mode	Code Number
Cooling	45
Heating	47

- You can set the code by pressing the **Temp** button.

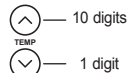

- Check if buzzer beeps.

- 4 Cut the power to the appliance.
- 5 Turn back on the power to the appliance after 30 seconds.

### Canceling the Cooling / Heating Only Mode

Follow the same procedure as 'Setting the Cooling / Heating Only Mode'. Please set the code number.

Mode	Code Number
Cooling	46
Heating	48

### NOTE

- Once the Cooling Only Mode is set, Heating, Auto Changeover can not be used.
- Once the Heating Only Mode is set, Cooling, Dehumidification, Auto Changeover can not be used.
- Once the function is canceled, it will returns to the normal state.
- The code can not be set while the appliance is operating. You can set the code when the appliance is turned off.
- If the code is not set while the appliance is turned off, the function will not operate.
- At Heating Only Mode, if the appliance gets turned off while the wireless remote control is set at other than Heating / Fan mode, the product will not get turned back on. Turn off the product after the wireless remote control is set at Heating / Fan mode and then turn back on.

# CHARGING THE REFRIGERANT

If the amount of refrigerant level is low, the appliance would provide low performance. Charge the refrigerant for proper operation.

- Refer to the label attached to the side of the appliance to confirm the type and amount of refrigerant.
- Charge the refrigerant through the gas service valve (larger pipe).
- Hoses or lines shall be as short as possible to minimise the amount of refrigerant contained in them.

- 1 Connect the low-pressure hose of the manifold gauge to the core valve of the gas service valve.

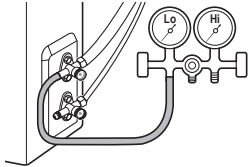

- 2 Open both the gas service valve and the liquid service valve of the outdoor unit.
  - Rotate the valves to counter-clockwise using a hexagon wrench.



- 3 Connect the charging hose of the manifold gauge to the refrigerant cylinder.

## Charge Using the Refrigerant Cylinder with a Siphon

- This is usually applied to R32. Charge the refrigerant (gas phase) by standing the refrigerant cylinder.

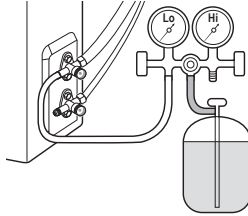

- 4 Charge the refrigerant by adjusting the low-pressure valve of the manifold gauge.
  - Refer to 'Suggested Amount of Refrigerant Charge'.
- 5 After charging the refrigerant, close the low-pressure valve of the manifold gauge and separate the connected low-pressure hose from the outdoor unit.

## NOTE

- Ensure that contamination of different refrigerants does not occur when using charging equipment.
- Extreme care shall be taken not to overfill the refrigerant system.
- Prior to recharging the system it shall be pressure tested with oxygen free nitrogen (OFN). The system shall be leak tested on completion of charging but prior to commissioning. A follow up leak test shall be carried out prior to leaving the site.
- The handling of the refrigerant must comply with national regulations.

## Suggested Amount of Refrigerant Charge

The amount of supplementary refrigerant can be different based on either appliance capacity or pipe length. Charge the proper amount of refrigerant based to the reference below.

Model	Capacity (kW)	Pipe Size			
		Gas		Liquid	
		mm	inch	mm	inch
Single Split	2.5 / 3.5	Ø 9.52	Ø 3/8	Ø 6.35	Ø 1/4
	5.0	Ø 12.70	Ø 1/2	Ø 6.35	Ø 1/4
Multi	1.5 / 2.1 / 2.5 / 3.5 / 4.2	Ø 9.52	Ø 3/8	Ø 6.35	Ø 1/4
	5.0	Ø 12.70	Ø 1/2	Ø 6.35	Ø 1/4

## Single Split Model

Capacity (kW)	Standard Length (m)	(A) Maximum Length (m)	(A) Minimum Length (m)	(B) Maximum Elevation (m)	Maximum Refrigerant Charge Amount (kg)	Amount of Additional Refrigerant (g/m)
2.5 / 3.5	7.5	15	3	7	0.85	20
5.0	7.5	20	3	10	1.25	20

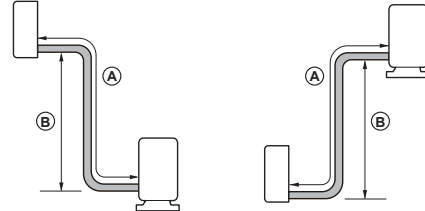

## NOTE

- The amount of refrigerant charged is based on the standardized pipe length. If the installed pipe is longer than the standard length, extra refrigerant needs to be added.
- Reliability cannot be guaranteed if the pipe is longer than the maximum length.
- It may cause reliability, performance, noise, and vibration problems, if piping limitations are not met. Ensure there's a minimum piping length, by making loops if necessary, if the indoor unit and outdoor unit are too close.

# PUMP DOWN

In case of appliance relocation and repair of the refrigerant system, operate the pump down process that brings the refrigerant from the indoor unit and pipes it to the outdoor unit to avoid refrigerant loss.

- Operate the pump down process in the cooling mode.
- 1 Remove the caps from the gas service valve, the liquid service valve, and the core valves in the outdoor unit.
  - 2 Connect the low-pressure hose of the manifold gauge to the core valve of the gas service valve.

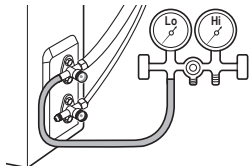

- 3 Operate the appliance in the cooling mode.
  - Operate the appliance more than 10 minutes after checking whether the compressor of the outdoor unit is operating properly.
- 4 Close the liquid service valve in the outdoor unit.
  - Rotate the valve clockwise using a hexagon wrench.



- 5 Close the gas service valve in the outdoor unit at a pressure of 0.5 kgf/cm<sup>2</sup> (14.2 to 7.1 psi).
  - Rotate the valve clockwise using a hexagon wrench.
- 6 Turn off the appliance.

## NOTE

- Do not operate the appliance for a long time. It may cause damage to the compressor.
- 7 Separate the low-pressure hose of the manifold gauge and the pipe connected to the outdoor unit.
    - Use a torque wrench and adjustable wrench.
  - 8 Close the caps from the gas service valve, the liquid service valve, and the core valves.
    - Tighten all the caps by using an adjustable wrench and torque wrench.

## NOTE

- Block the outdoor valve by screwing a flare nut through the pipe after welding the end of the separated pipe. This can protect the appliance from air, vapor, and foreign substances.

## ⚠ WARNING

- Operating the appliance while it is disconnected to the pipe could result in explosion and damage. Use the appliance after connecting it to the pipe once the appliance has been relocated and the refrigerant circuit repaired.

**Memo**

